



■ Features :

- Universal AC input / Full range(up to 305VAC)
- Protections:Short circuit/Over load/Over voltage/Over temperature
- Built-in active PFC function
- High efficiency up to 90%
- Cooling by free air convection
- IP65 design for indoor and outdoor installations
- Small and compact size
- High reliability,low cost
- Suitable for LED lighting and moving sign applications
- 3 years warranty



SPECIFICATION

MODEL		HSG-70-12	HSG-70-18	HSG-70-24	HSG-70-36	HSG-70-48
OUTPUT	DC VOLTAGE	12V	18V	24V	36V	48V
	CONSTANT CURRENT REGION Note.5	7.7 ~ 12V	11.3 ~ 18V	15.5 ~ 24V	22.1 ~ 36V	29.3 ~ 48V
	RATED CURRENT	5.0A	4.0A	3.0A	2.0A	1.5A
	RATED POWER	60W	72W	72W	72W	72W
	CURRENT ADJ. RANGE	Can be adjusted by internal potentiometer				
		3 ~ 5A	2.4 ~ 4A	1.8 ~ 3A	1.2 ~ 2A	0.9 ~ 1.5A
	RIPPLE & NOISE (max.) Note.2	150mVp-p	200mVp-p	200mVp-p	200mVp-p	200mVp-p
	VOLTAGE TOLERANCE Note.3	±2.5%	±2.0%	±1.0%	±1.0%	±1.0%
	LINE REGULATION	±0.5%	±0.5%	±0.5%	±0.5%	±0.5%
	LOAD REGULATION	±2.0%	±1.5%	±0.5%	±0.5%	±0.5%
SETUP, RISE TIME Note.7	2000ms,80ms / 115VAC 1000ms,80ms / 230VAC at full load					
HOLD UP TIME	16ms at full load 230VAC/115VAC					
INPUT	VOLTAGE RANGE Note.4	90 ~ 305VAC 127~431VDC				
	FREQUENCY RANGE	47 ~ 63Hz				
	POWER FACTOR(Typ.)	PF≡0.96/115VAC, PF≡0.96/230VAC,PF>0.92/277VAC at full load(please refer to "Power Factor characteristic curve")				
	EFFICIENCY(Typ.)	88%	89%	89%	90%	90%
	AC CURRENT	0.85A/115VAC	0.425A/230VAC	0.4A/277VAC		
	INRUSH CURRENT(Typ.)	Cold start 70A/230VAC				
LEAKAGE CURRENT	<0.75mA / 277VAC					
PROTECTION	OVER CURRENT Note.5	95 ~ 108% Protection type : Constant current limiting, recovers automatically after fault condition is removed				
	SHORT CIRCUIT	Protection type : Hiccup mode, recovers automatically after fault condition is removed.				
	OVER VOLTAGE	14 ~ 17V	21 ~ 25V	28 ~ 34V	41 ~ 48V	54 ~ 63V
		Protection type : Shut down o/p voltage, re-power on to recover				
	OVER TEMPERATURE	100°C±10°C (RTH2) Protection type : Shut down o/p voltage, re-power on to recover				
ENVIRONMENT	WORKING TEMP.	-40 ~ +70°C (Refer to "Derating Curve")				
	WORKING HUMIDITY	20 ~ 95% RH non-condensing				
	STORAGE TEMP., HUMIDITY	-40 ~ +80°C, 10 ~ 95% RH				
	TEMP. COEFFICIENT	±0.03%/°C (0 ~ 50°C)				
	VIBRATION	10 ~ 500Hz, 5G 10min./1cycle, period for 60min. each along X, Y, Z axes				
SAFETY & EMC	SAFETY STANDARDS	IP65 approved; design refer to TUV EN61347-1, EN61347-2-13, UL8750				
	WITHSTAND VOLTAGE	I/P-O/P:3.75KVAC I/P-FG:1.88KVAC O/P-FG:0.5KVAC				
	ISOLATION RESISTANCE	I/P-O/P, I/P-FG, O/P-FG:100M Ohms/500VDC / 25°C / 70%RH				
	EMC EMISSION	Compliance to EN55015,EN61000-3-2 Class C(≡65% load);EN61000-3-3				
	EMC IMMUNITY	Compliance to EN61000-4-2,3,4,5,6,8,11; EN61547, EN55024, light industry level (surge 4KV), criteria A				
OTHERS	MTBF	338.2Khrs min. MIL-HDBK-217F (25°C)				
	DIMENSION	127.2*90*38.8mm (L*W*H)				
	PACKING	0.76Kg;16pcs/ 12.3Kg/0.57CUFT				
NOTE	<p>1. All parameters NOT specially mentioned are measured at 230VAC input, rated load and 25°C of ambient temperature.</p> <p>2. Ripple & noise are measured at 20MHz of bandwidth by using a 12" twisted pair-wire terminated with a 0.1uf & 47uf parallel capacitor.</p> <p>3. Tolerance : includes set up tolerance, line regulation and load regulation.</p> <p>4. Derating may be needed under low input voltage, please check the static characteristics for more details.</p> <p>5. Constant current operation region is within 65% ~100% rated output voltage. This is the suitable operation region for LED related applications, but please reconfirm special electrical requirements for some specific system design.</p> <p>6. The power supply is considered as a component that will be operated in combination with final equipment. Since EMC performance will be affected by the complete installation, the final equipment manufacturers must re-quality EMC Directive on the complete installation again.</p> <p>7. Length of set up time is measured at cold first start. Turning ON/OFF the power supply may lead to increase of the set up time.</p>					

Mechanical Specification

Case No.209B Unit:mm

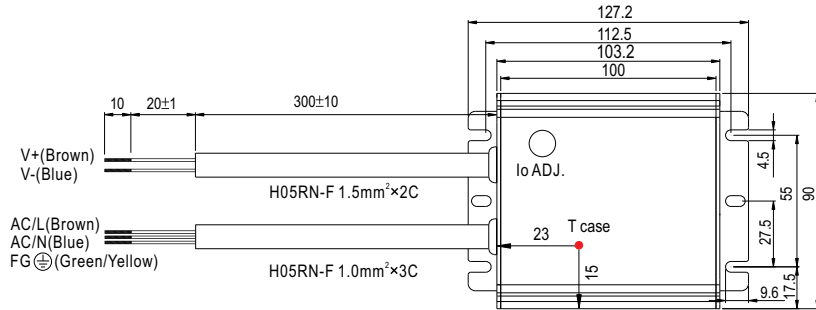

※ T case: Max. Case Temperature

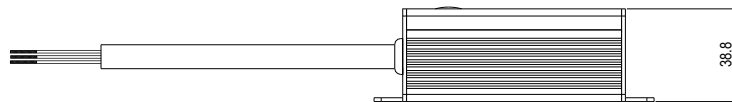

※ IP65 rated. Constant current level can be adjusted through internal potentiometer.
 (Can access by removing the rubber stopper on the case.)

Block Diagram

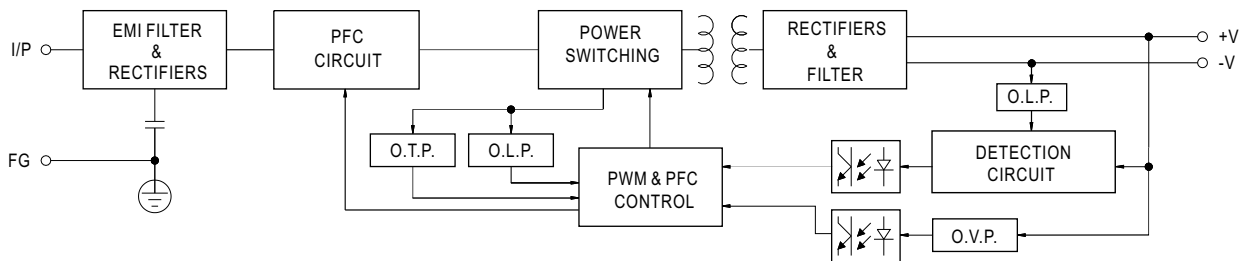

Derating Curve

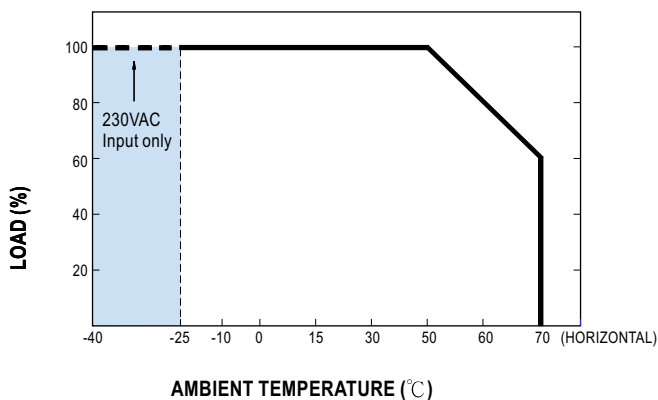

Static Characteristics

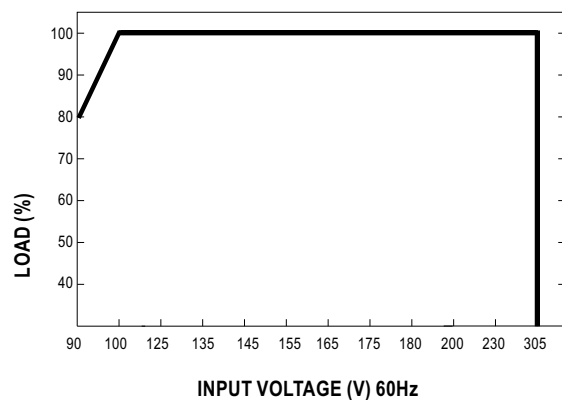

Power Factor Characteristic

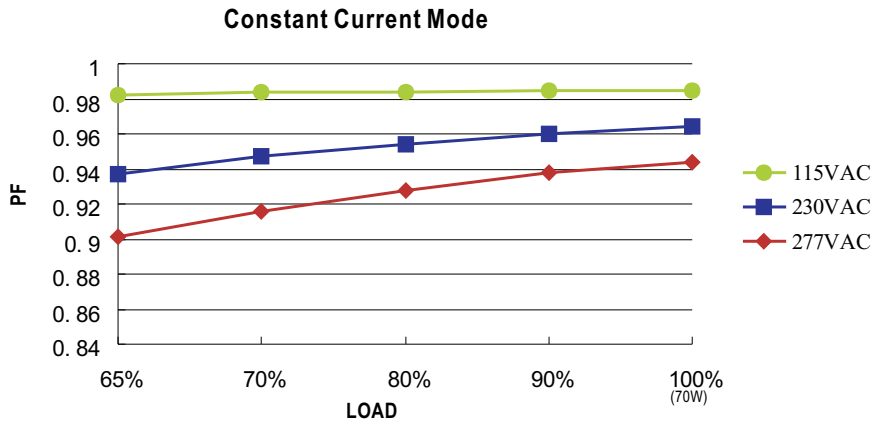

EFFICIENCY vs LOAD (48V Model)

HSG-70 series possess superior working efficiency that up to 90% can be reached in field applications.

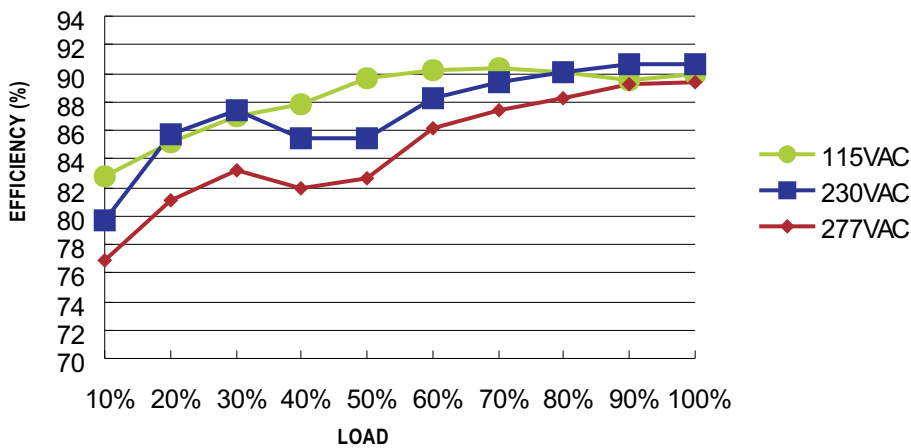

DRIVING METHODS OF LED MODULE

There are two major kinds of LED drive method "direct drive" and "with LED driver".

A typical LED power supply may either work in "constant voltage mode (CV) or constant current mode (CC)" to drive the LEDs.

Mean Well's LED power supply with CV+ CC characteristic can be operated at both CV mode (with LED driver, at area (A) and CC mode (direct drive, at area (B)).

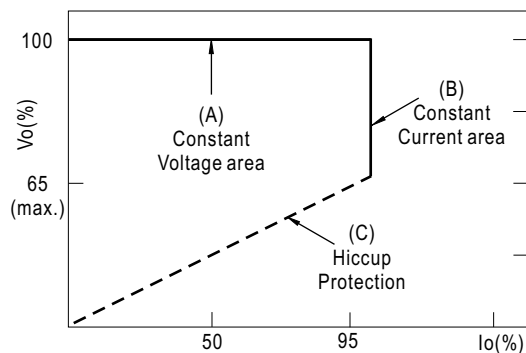

Typical LED power supply I-V curve